

Experimental analysis of influence of initially stressed springs and parameters of excitation on vibration absorber effectiveness

MSc, Eng. Piotr Jan Sulich

Supervisor: PhD, Eng. Michael Pracik

Abstract

The paper presents results of experimental analysis of a dynamic model of a vibration absorber. The possibility of application of the device to vibration damping of pipeline element is considered. It is assumed one degree of freedom system under harmonic excitation. There was investigated effectiveness of two different kinds of the absorber assembly – at vertical and at angled position. At the first assembly - vertical position – there have been compared characteristics of system with or without initially stressed springs. For the second assembly - angled position – there has been examined influence of different power excitation at the same frequency on behaviour of the system. The second type of fixation at angled position of dynamic absorber was tested with a special frame which allowed work at given angle. It has been adjusted harmonic signal, frequency of 11.65 [Hz]. In a few steps there was being controlled excitation power in the range: 0,2 [A] and 4 [V] to 0,9 [A] and 15 [V].

Keywords

oscillation, pipeline vibration damping, dynamic absorbers,

1. Introduction

Motivation of preparing presented model was problem of vibration damping for industrial piping. If we considered place of vibration formation, sources of vibration in pipeline could be divided into two groups: external and internal, as presented in *Fig 1*. In the first group, oscillations are created by wind blowing perpendicularly to the pipe axis or machines which support pipeline. To the second group belong vibrations connected with fluid flow inside pipeline: pulsation of fluid caused by rotation of pump rotor and by strikes the fluid against internal walls of pipeline.

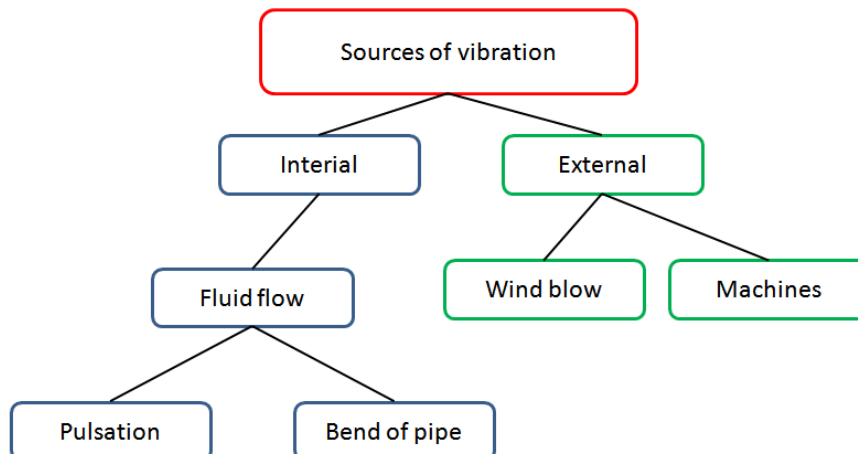

Fig. 1. Sources of vibration in pipeline

2. Examples of vibration reduction

Vibrations of pipeline are very dangerous for stability of construction and for people working directly in zone of piping (esp. in cases of piping with danger substances). From economical point of view vibration could cause disconnections of the pipeline parts and bring waste of money.

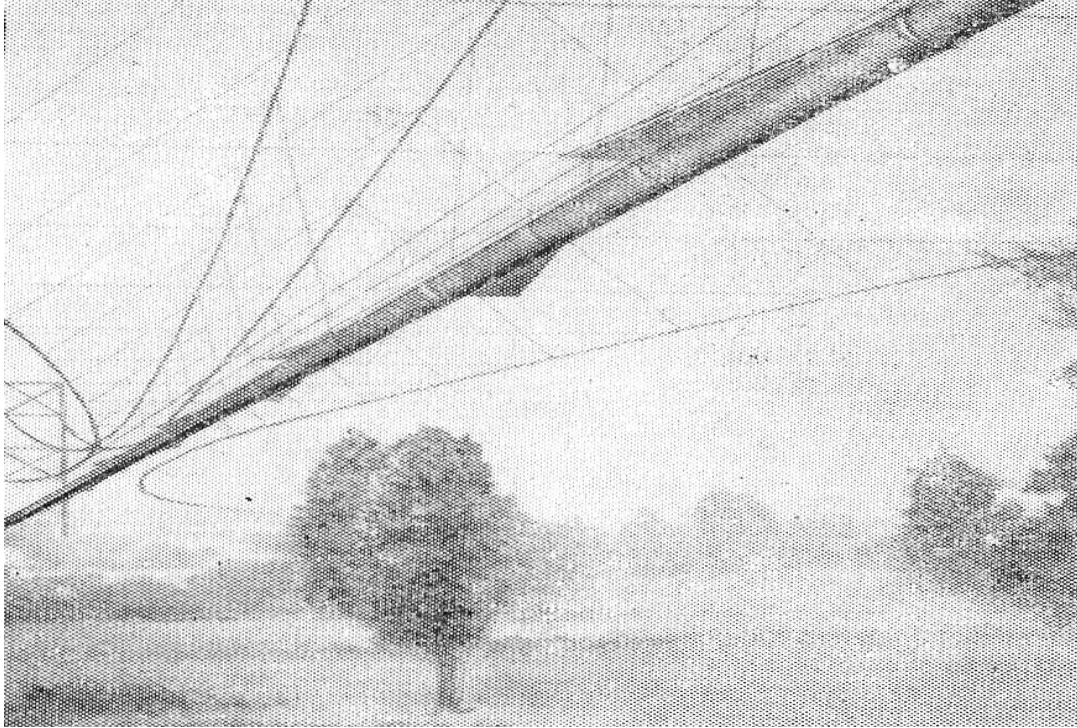

Fig. 2. Examples of prevention vibration in pipeline - triangular shape separation wind [5]

There exists a few idea of vibration reduction with different efficiency. If vibrations are caused by wind formation of Karman's vortex street on the pipeline this is a strongly negative phenomenon which is caused by changes of air pressure. One of possibility to prevent formation of vibrations is to mount pieces of metal sheet on the pipeline. Such additional parts have mostly triangular shape. They are installed along piping as presented on *Błąd! Nie można odnaleźć źródła odwołania.* 2. Shape and localization of installed pieces should separate zone of pressure changes. In the long term of using it counteract of formation Karman's vortex street and vibration with frequency close to resonance.

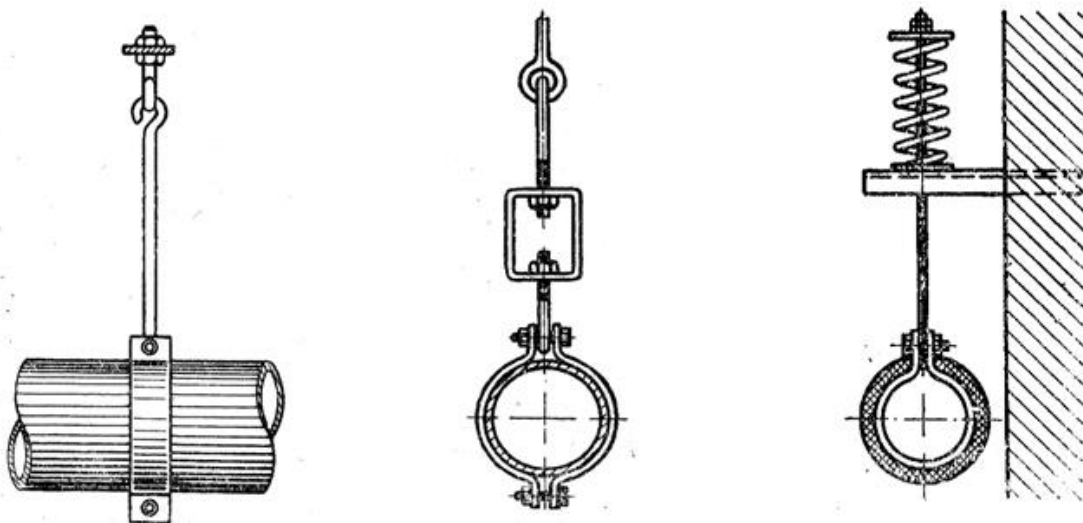

Fig. 3. Examples of prevention vibration in pipeline – vibroisolation [5]

Completely different sources of vibration are connected with work of pump and bend of the pipeline. It seems obviously that resonance characteristics of piping should be respected while choosing a pump working parameters. The problem of cooperation pump and pipeline brings some difficulties. First of all is to reduce of pressure losses on the base of a piezometric diagram but also important is the pressure pulsation and the pump dynamic actions. In most of cases they are responsible for the fatigue cracking and damage the fluid flow machine rotational elements. Harmonic changes of fluid flow inside the pipeline could be source of vibrations. The pipeline resonance vibrations excite not only constrains approximate to its natural frequency. The best for recognizing of the piping resonance characteristics is to apply suitable external excitation. Thanks to that, it could be found the system response in a wide band of frequency constraints. According that is determined rotational speeds recommended and forbidden for the device.

A little different problem but still connected with fluid flow inside pipeline is fluid hit to the walls of pipe, especially at the bend of pipeline. It is also dangerous phenomenon. The elements of fluid strike with some velocity and frequency on the wall. It could lead extremely to displacements of pipeline pieces. It looks like a problem with changes of temperature and compensation of pipe length. In addition frequency of striking of fluid could be source of vibrations. In cases of compatibility of this frequency to natural frequency it could cause disconnection of pipeline elements.

To prevent formation of vibrations connected with pulsation of fluid transported by rotary machine ought to be changed parameters of pump. An idea is also changing stiffness of pipeline or addition parts to compensate vibrations as it is presented on *Fig 3.* and *Fig 4.* Problem of piping compensation is well known usually as temperature compensation of system. Compensation of pipeline when appear vibrations is connected with changing in local point stiffness (*Fig 3.*), add some rubber and the most significant change support (*Fig. 4*). All of mentioned ways have influence on geometry of the system.

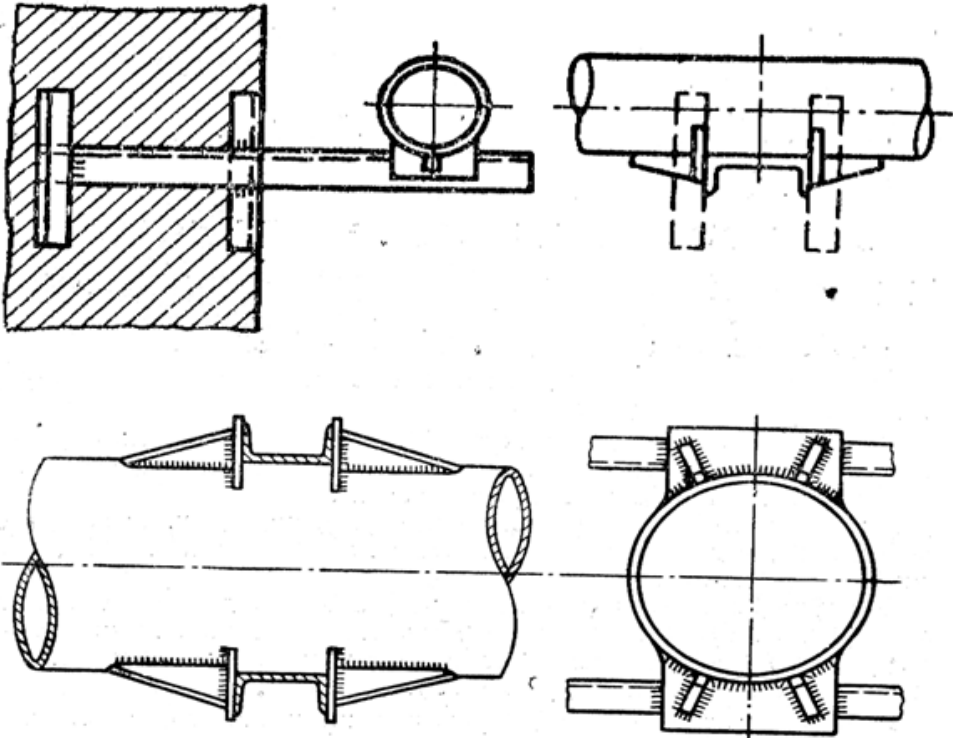

Fig. 4. Examples of prevention vibration in pipeline -locally changed stiffness

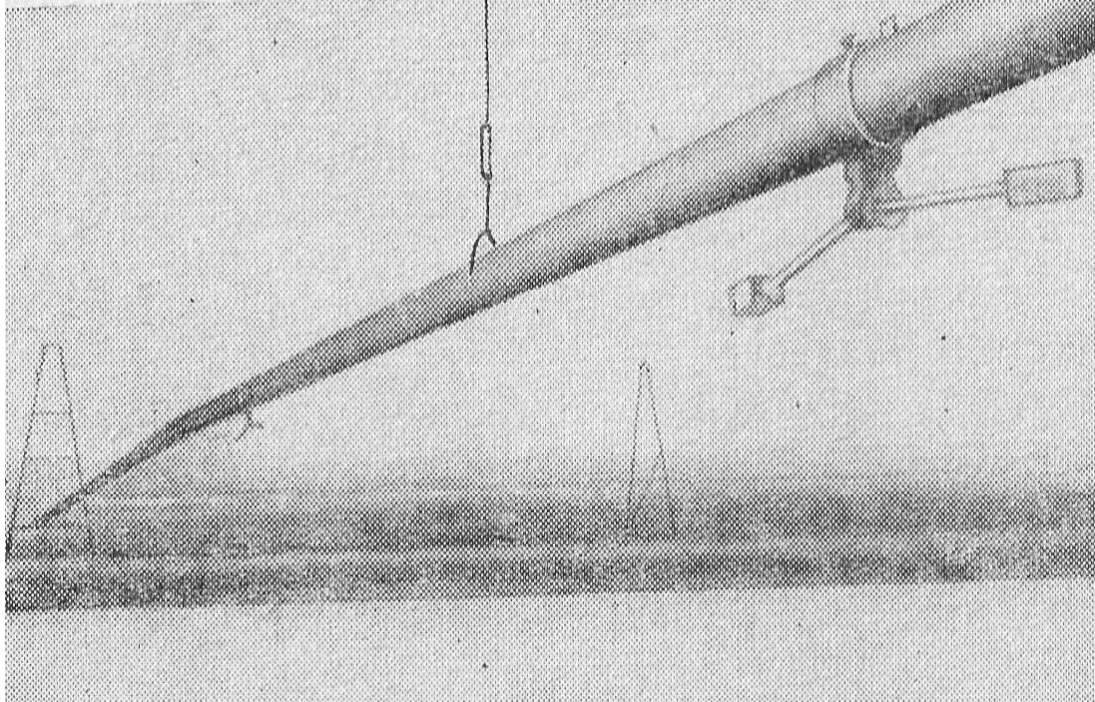

Fig.5. Examples of prevention vibration in pipeline - additional mass[5]

Another way of reduction of pipeline vibrations is use a dynamic absorber or damper. It provides no prevention of vibration creation but to eliminate them after their formation. An example of such a device is Stockbridge's damper. It is presented in *Błąd! Nie można odnaleźć źródła odwołania. 5* and this invention is usually utilizing at high voltage energetics. Nowadays it is also used in pipeline systems - shown in *Błąd! Nie można odnaleźć źródła odwołania. 5* Stockbridge's damper consist of three basic elements: two moving weights messenger wires or rod and clamp.

There have been presented above different sources of vibrations and ways of pipeline preventions and has been given slightly basic information. Some of them seems very easy bring to life. Very important is that in reality geometry of support or geometry of pipeline system should not to be changed. In real system, compensation of piping rarely has significant result on pulsation of fluid. The most effective is addition some mass without influence on the geometry of support or structure of the whole system.

3. Model of dynamic absorber

It has been assumed one degree of freedom system under harmonic excitation $\xi(t)$, presented in *Fig. 6*. Model consists of mass moved along the rod, between two supports with two bearings and two springs with changeable initial stress.

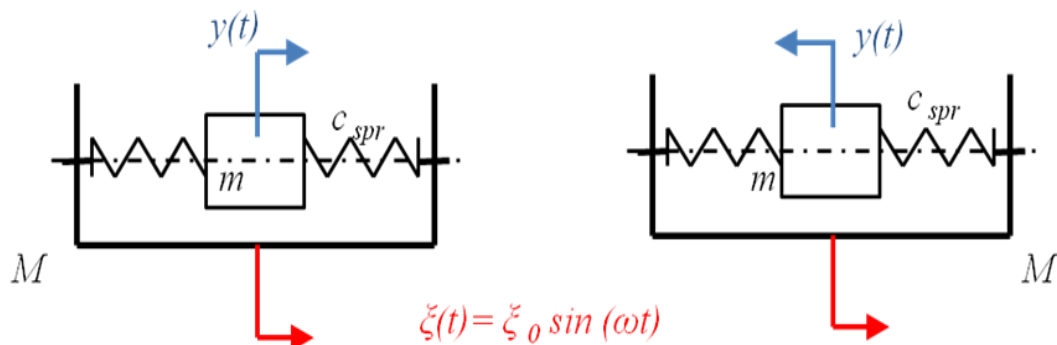

Fig. 6. Model for dynamic analysis of absorber work

From dynamic analysis of absorber model could be written two dynamic equations of motion:

- for model without relative movement of masses m and M :

$$\ddot{\xi}(t) = \ddot{y}(t) \quad (1)$$

- for model with relative movement of masses m and M :

$$m\ddot{y}(t) = -2c_{spr}(y(t) + \xi(t)) - T \quad (2)$$

4. Measurement

There has been investigated effectiveness of two different kinds of the absorber assembly – at vertical and at angled position as presented in **Fig 7**. There were utilized two type of instrumentation. At first assembly - vertical position - there have been compared characteristics of system with or without pre-tensioned springs. For second assembly - angled position - there has examined influence different power of excitation at the same frequency on behaviour of the system.

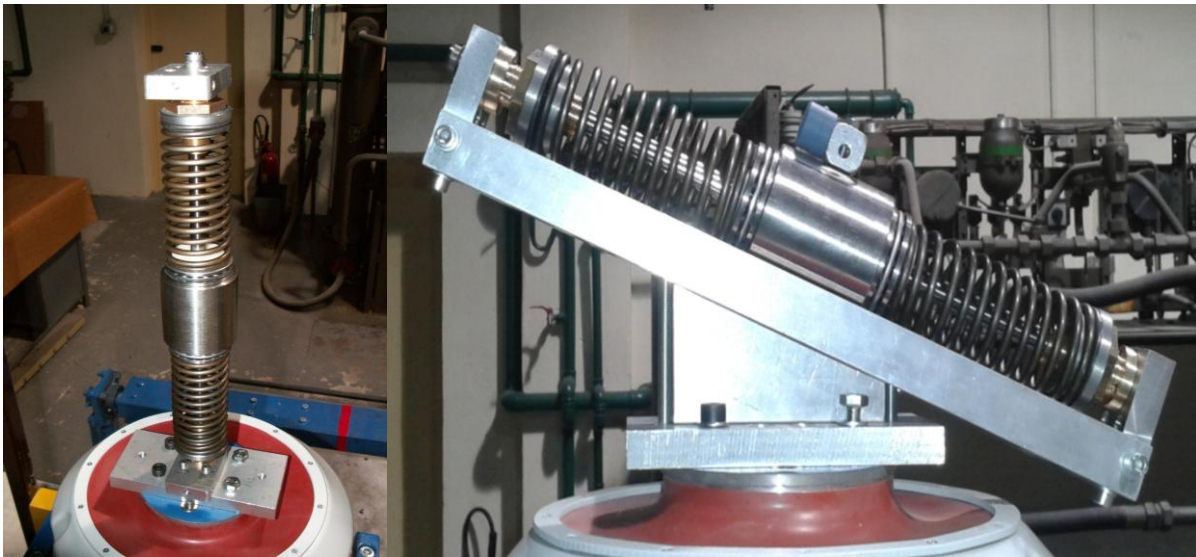

Fig. 7. Vertical and angled configuration of absorber work.

3.1 Vertical configuration

For vertical position presented in **Fig. 10** there were used: generator RIGOL DG1022, signal conditioner PCB 584, two accelerometers 336C04 PCB and Dual Channel Signal Analyzer Type 2034 Brüel & Kjær.

At the first type of assembly - with initial stress - there was obtained natural frequency equal 13,875 [Hz]. System response taken by Dual Channel Signal Analyzer Type 2034 Brüel & Kjær for springs pre-tensioned is presented in **Fig. 8**. At second type when damper was working without initially stressed springs, the natural frequency was equal 11,875 [Hz] and it is presented in **Fig. 9**. There was observed that increase in value of natural frequency of system is connected with input tension of springs.

Table 1. – Influence of initial tension on natural frequency of absorber model

Nr of measurement	Length of upper spring [mm]	Length of lower spring [mm]	Frequency [Hz]
1	tension		13,875
	102	102	
2	without tension		11,875
	113	111	

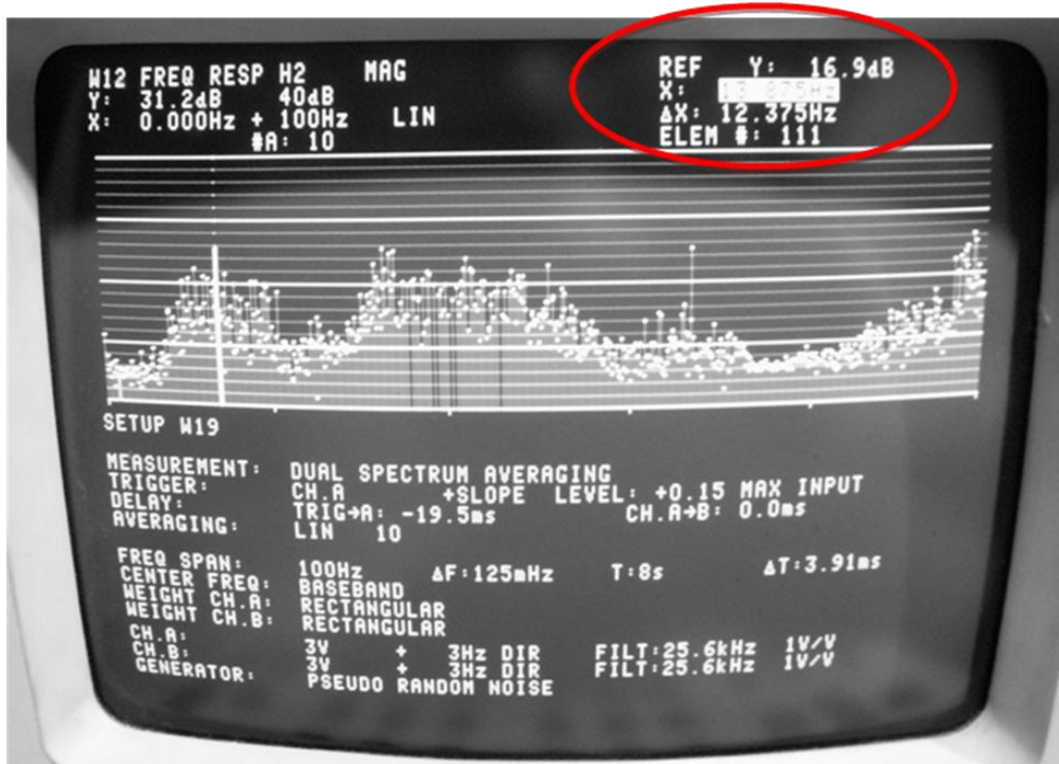

Fig. 8. System response taken by Dual Channel Signal Analyzer Type 2034 Brüel & Kjær for model with initially stressed springs.

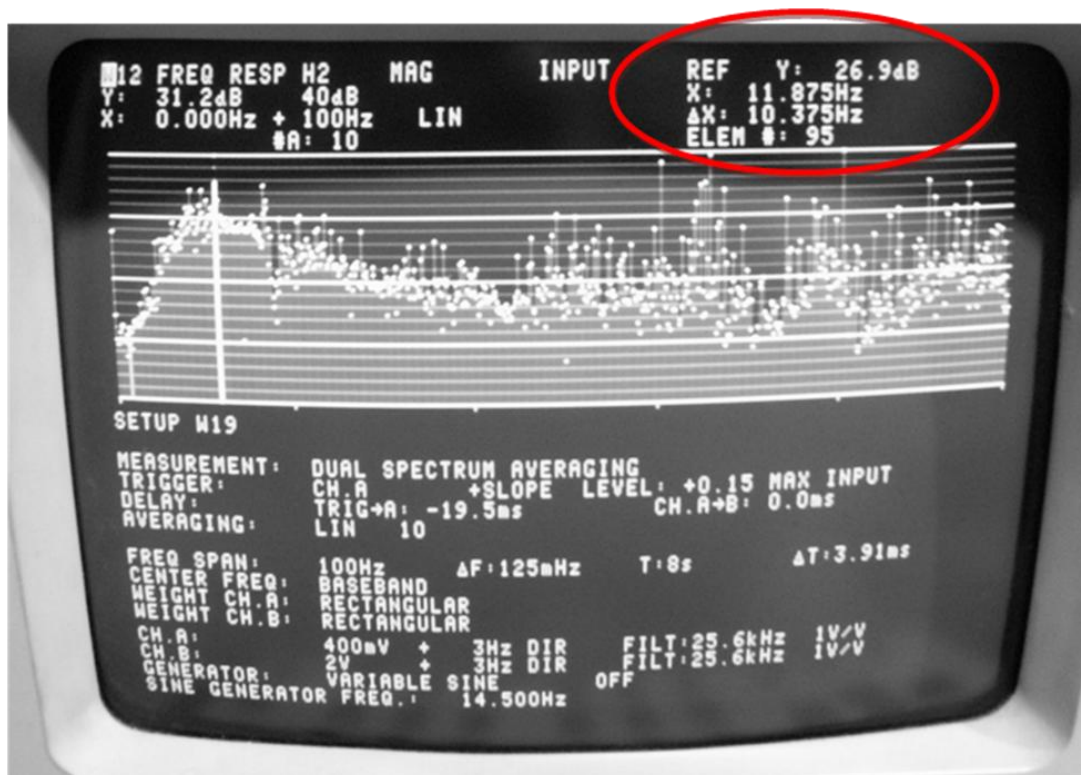

Fig. 8. System response taken by Dual Channel Signal Analyzer Type 2034 Brüel & Kjær for model without initially stressed springs.



Fig. 10. Measurement instrumentation:

*1 – Dual Channel Signal Analyzer Type 2034 Brüel & Kjær; 2 – generator RIGOL DG1022
3 – signal conditioner PCB 584; 4 – two accelerometers 336C04 PCB attached to the model*

3.2 Angled configuration

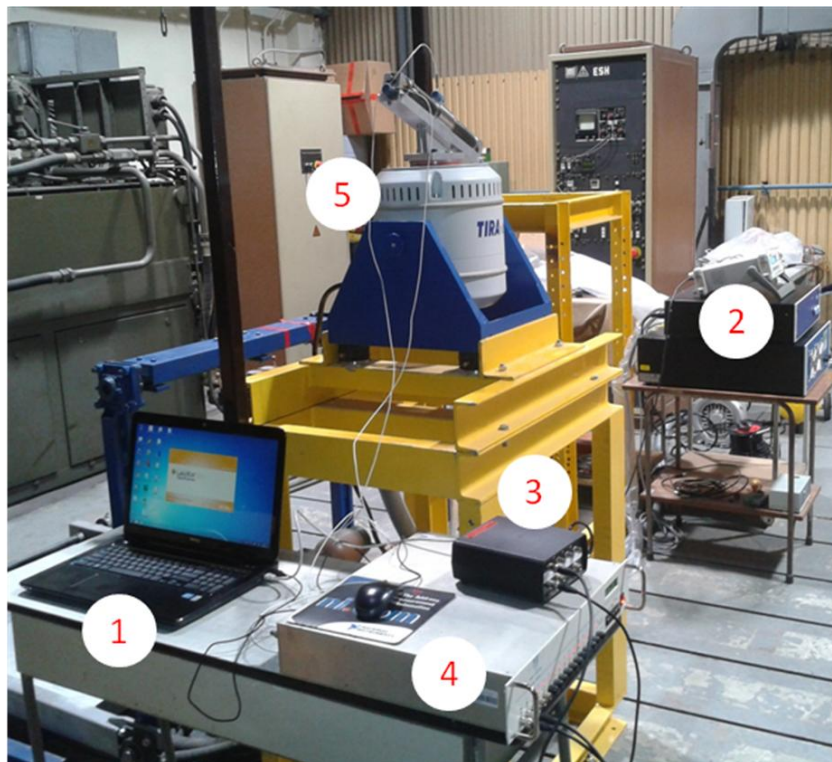

Fig. 11. Measurement instrumentation:

*1 – PC; 2 – generator RIGOL DG1022; 3 – A/D converter card NI - USB 6009
4 – signal conditioner PCB 584; 5 – two accelerometers 336C04 PCB attached to the model*

The second type of assembly let put dynamic absorber in angled position. Then it has been tested with a special frame which allowed work at an angle 23 degrees. On the generator RIGOL DG1022 was adjusted sinusoidal signal, frequency of 11.65 [Hz]. Measurement instrumentation for angled position is presented in *Błąd! Nie można odnaleźć źródła odwołania.. 11*: generator RIGOL DG1022, A/D converter card NI-USB6009, signal conditioner PCB 584, two accelerometers 336C04 PCB and PC.

Table 2. – List of checked power supply RMS parameters of exciter

Measurement No.	Electric current [A]	Voltage [V]	FFT spectrum
1	0,2	4	(1) 11,66; (2) 23,32; (3) 34,97; (4) 46,69; (5) 58,23
2	0,3	6	(1) 11,66; (2) 23,32; (3) 34,97; (4) - ; (5) 58,23
3	0,4	7	(1) 11,66; (2) 23,32; (3) 34,97; (4) 46,69; (5) 58,23
4	0,4	8	(1) 11,66; (2) 23,32; (3) 34,97; (4) 46,69; (5) 58,23
5	0,7	12	(1) 11,66; (2) 23,32; (3) 34,97; (4) 46,69; (5) -
6	0,8	13,5	(1) 11,66; (2) 23,32; (3) -; (4) 46,69; (5) -
7	0,9	14	(1) 11,66; (2) -; (3) 34,97; (4) -; (5) 58,23
8	0,9	15	(1) 11,66; (2) -; (3) 34,97; (4) -; (5) 58,23

Three ranges of model work were investigated during experiments. In blue colour are marked stable ranges of work **Table 2**. For others parameters model worked unstable. In eight steps there was increased power of excitation from 0,2 [A] and 4 [V] to 0,9 [A] and 15 [V] as it is shown in **Table 2**. Results of examined damper are presented below in figures of system time responses and FFT spectrums taken from accelerometers for different exciter power supply RMS parameters.

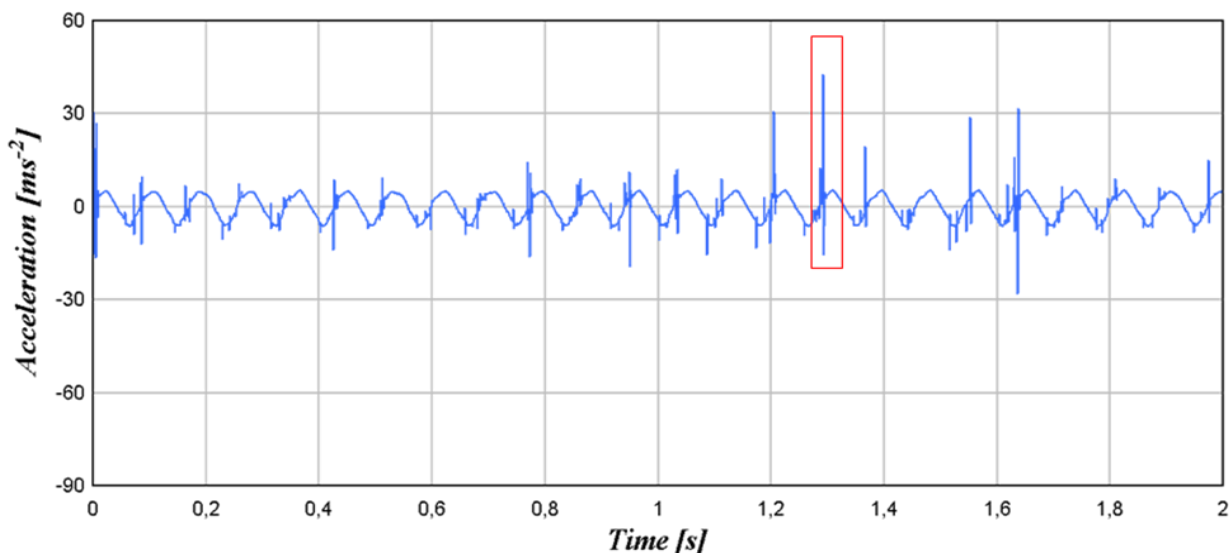

Fig. 12. System response taken from accelerometers for power supply RMS parameters of exciter 0,3 [A] and 6 [V]

During analysis of system response taken from accelerometers for power supply RMS parameters of exciter 0,3 [A] and 6 [V], presented in **Fig. 12**, localized some peaks: strongly increasing acceleration at point signed red frame and shown in **Fig 13**. Rapidly increasing

value of acceleration was connected with an attempt to break frictional engagement between mass m and a rod. In spectrum could not be observed all frequencies, it lost fourth (**Fig. 14**).

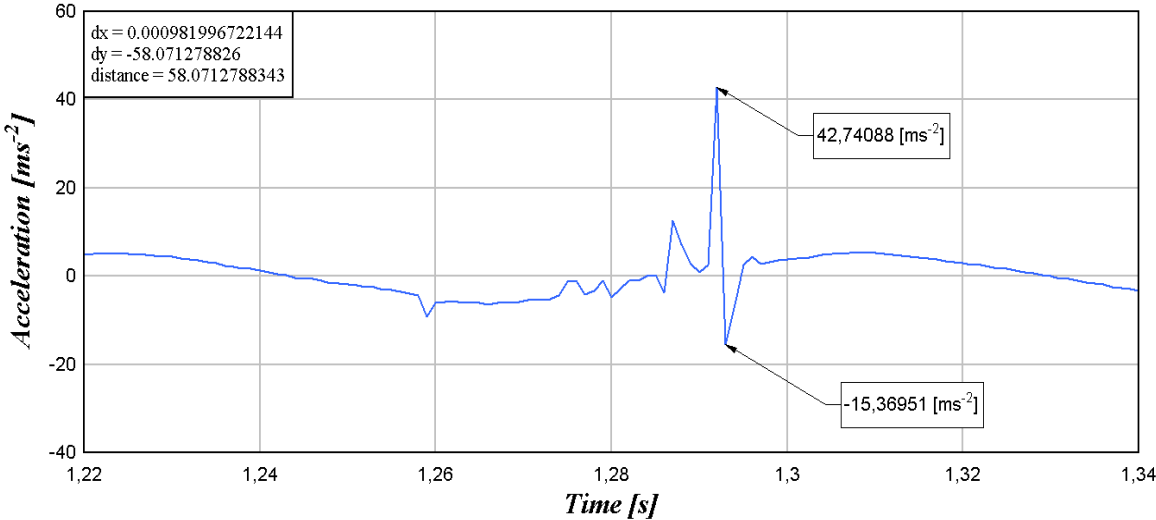

Fig. 13. Peak connected with attempt to break frictional engagement for parameters 0,3 [A] 6 [V].

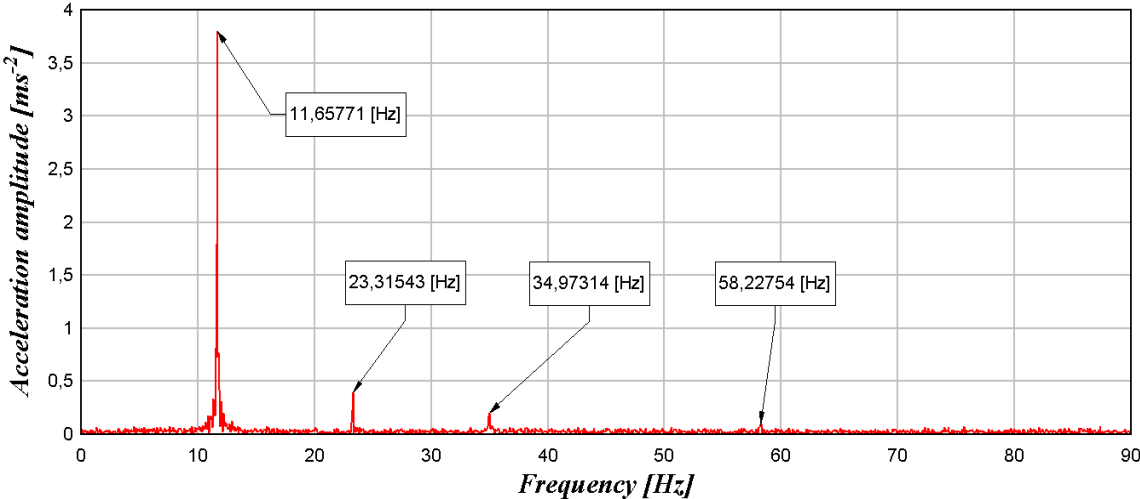

Fig. 14. FFT spectrum for excitation with parameters 0,3 [A] and 6 [V].

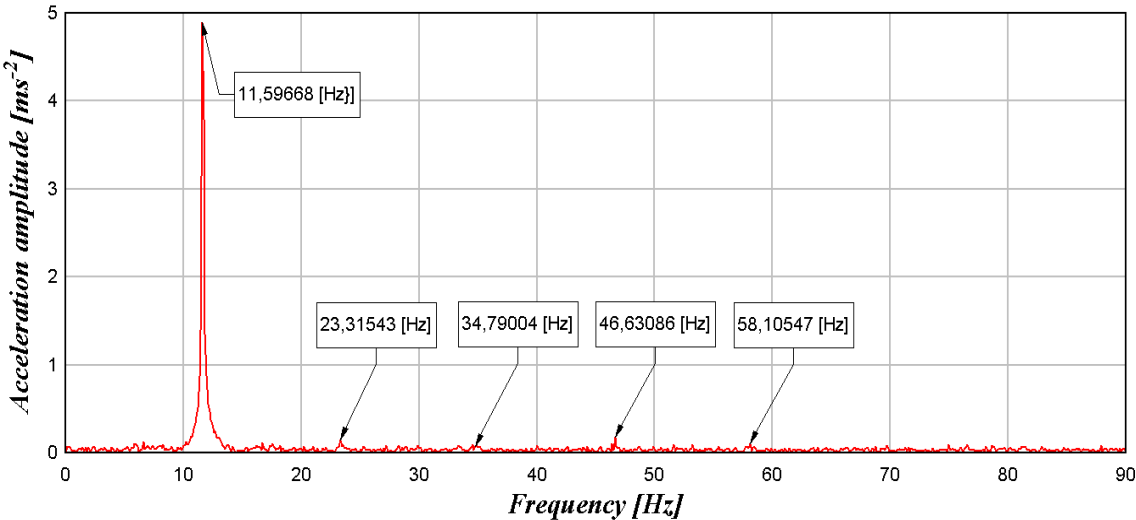

Fig. 15. FFT spectrum for excitation with parameters 0,4 [A] and 8 [V].

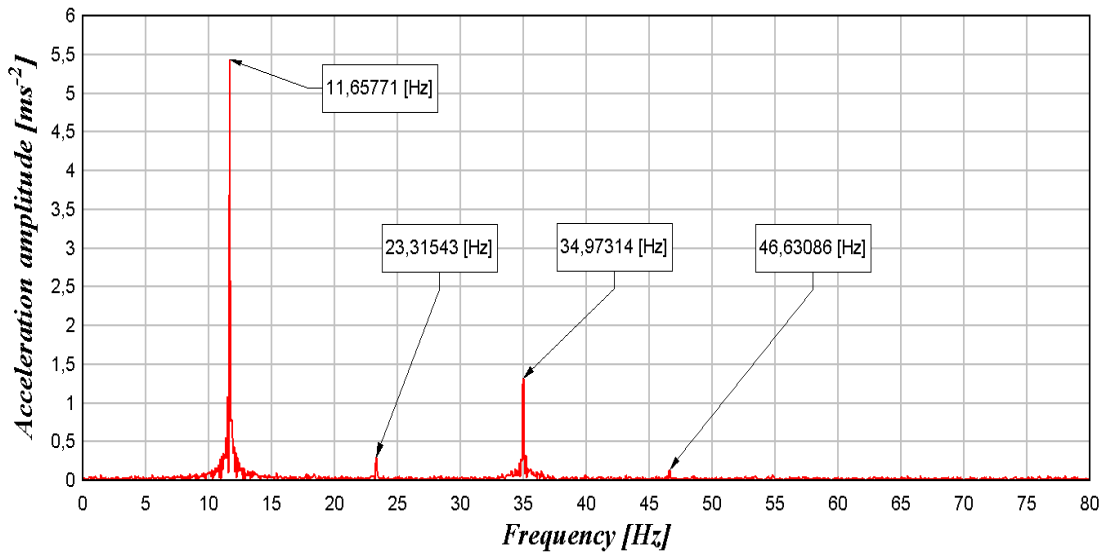

Fig. 16. FFT spectrum for excitation with parameters 0,7 [A] and 12 [V].

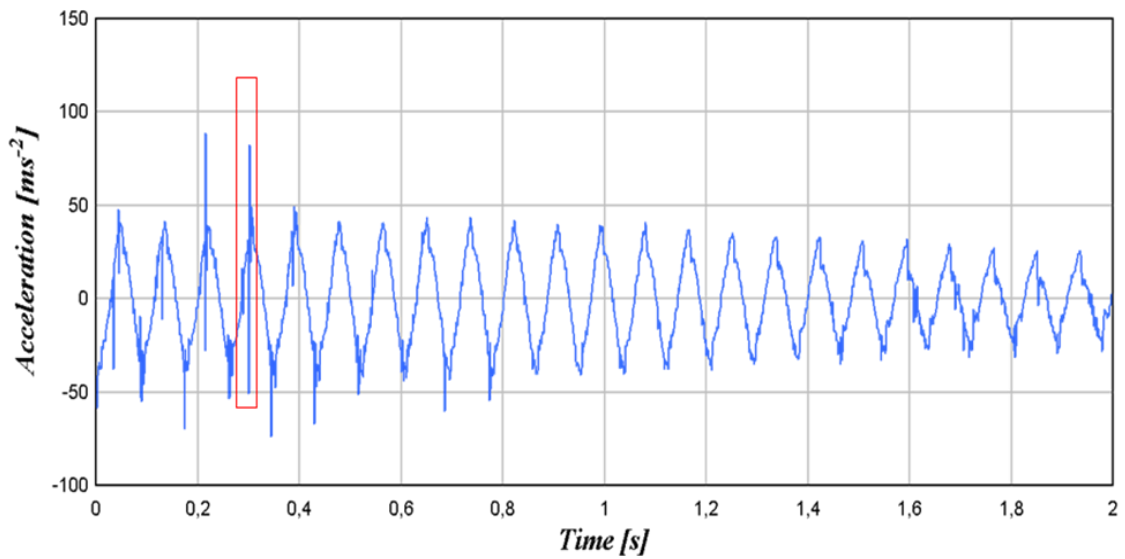

Fig. 17. System response taken from accelerometers for power supply RMS parameters of exciter 0,9 [A] and 15 [V]

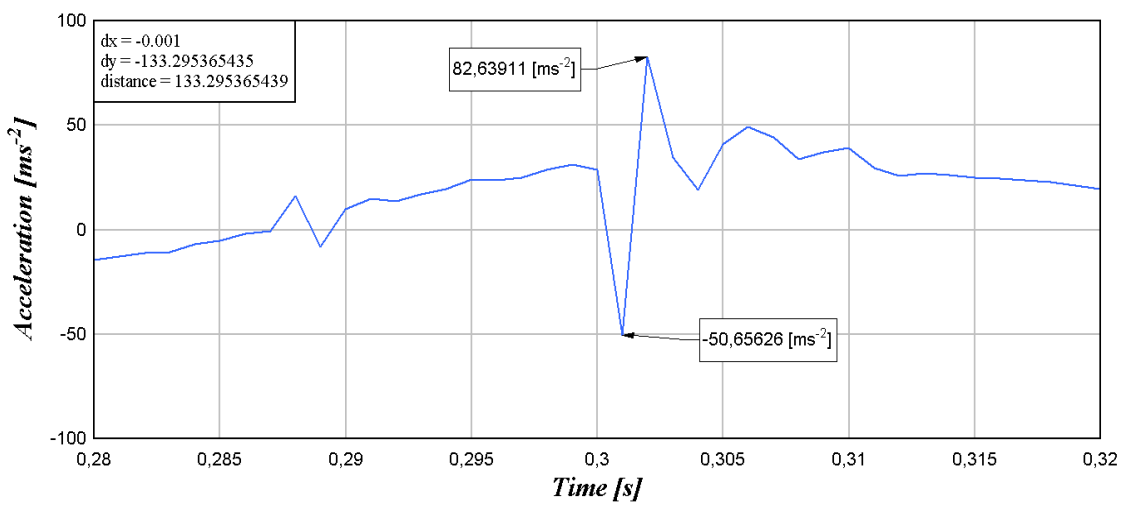

Fig. 18. Peak connected with impact spring against bearing and mass situated between them for parameters 0,9 [A] i 15 [V]

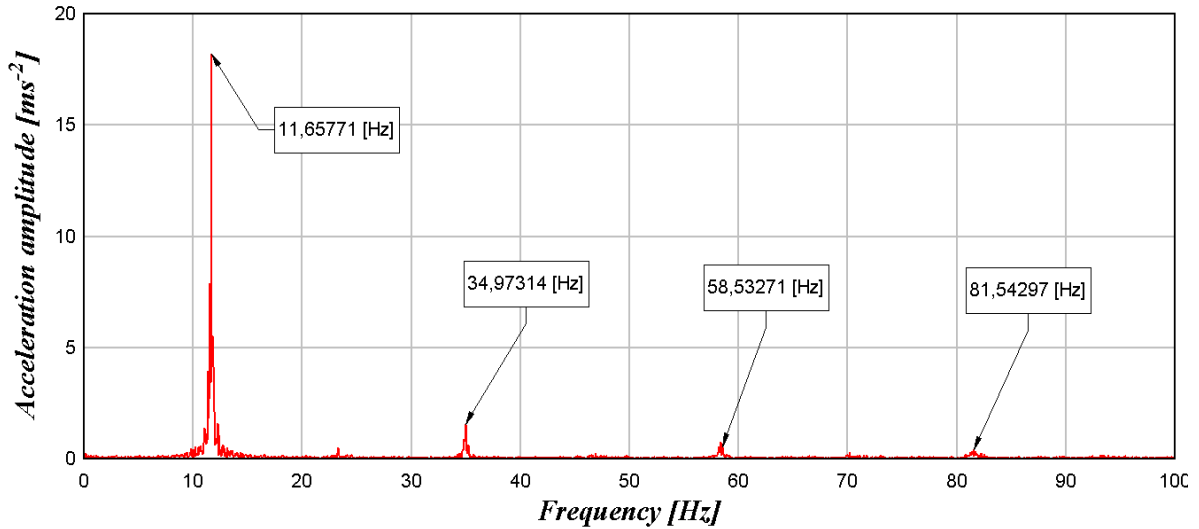

Fig. 19. FFT spectrum for excitation with parameters 0,9 [A] and 15 [V].

Increasing power of excitation up to 0,4 [A] and 8 [V] we observed stable work of absorber. In spectrum FFT (**Fig. 15**) appeared sequence of frequencies: 11,65 [Hz], 23,3 [Hz], 34,8 [Hz], 46,6 [Hz], 58 [Hz]. Increase of excitation power to 0,7 [A] and 12 [V] influenced on proper work of absorber. In **Fig. 16** in spectrum FFT were forced only odd frequencies. For maximum of excitation power at parameters 0,9 [A] and 15 [V], in system response (**Fig. 17**), appeared again some peaks. In this time rapidly increasing acceleration was connected with impact in the system. Peak connected with impact (**Fig. 18**) was almost three times higher than in the frictional case (**Fig. 13**). FFT spectrum presented in **Fig 19** confirmed existence of impact of springs against bearings and mass m situated between them, the proof is increasing sequence of odd frequencies: 11,65 [Hz], 34,9 [Hz], 58,53 [Hz] and 81,54 [Hz] that appears in analysed spectrum.

4. Conclusion

Experimentally was proved that initial stress of spring influence on increase of natural frequency of dynamic absorber. It was also examined that work of vibration damper with pre-stressed springs is strongly connected with parameters of kinematic excitation, putting from electro-dynamic exciter. For the analysed model there were found three ranges of work, two of them are unstable. Over the range of parameters of excitation 0,3 [A] and 6 [V] to 0,7 [A] and 12 [V] the model was working properly. Experimental analysis of the model has confirmed that it could be useful as an absorber for oscillating pipeline. It was proved that device had the best damping efficiency for narrow range of resonance.

Symbols

c_{spr}	spring stiffness	(N·m ⁻¹)
M, m	mass	(kg)
T	friction force	(N)
t	time	(s)
$y(t)$	displacement function	(m)
$\xi(t)$	displacement excitation-function	(m)

References

- 1 Bęczkowski W., Rurociągi energetyczne, cz. II Sprężystość i wytrzymałość układów, Wydawnictwa Naukowo-Techniczne, Warszawa 1965.
- 2 Beards C. F., Structural Vibration: Analysis and Damping, Butterworth-Heinemann, London 1996.
- 3 Gatti P. L., Ferrari V., Applied Structural and Mechanical Vibrations. Theory, methods and measuring instrumentation, Taylor & Francis Group LLC, New York 2003.
- 4 Łączkowski R., Wibroakustyka maszyn i urządzeń, Wydawnictwa Naukowo-Techniczne, Warszawa 1983.
- 5 Гладких П. А., Хачатурян С. А., Предупреждение и устранение колебаний нагнетательных установок, Moskwa 1964.
- 6 Harris C. M., Piersol A. G., Harris' Shock and Vibration Handbook, McGraw Hill, New York 2002.
- 7 Thomson W. T., Theory of Vibration with Applications, Prentice-Hall, Englewood Cliffs 1972.
- 8 Zachwieja J., Gawda M., "Properties Diagnosing of Dynamic Pipeline-Pomp System in Terms of Vibration Damping Possibility", in: Diagnostyka, vol 4 (40)/2006, p. 27-31.